

8J2862-02

KODAK 1500 Intraoral Camera

User's Guide



Notice

©Carestream Health, Inc., 2010. No part of this publication may be reproduced, stored in a retrieval system, translated to another language, or transmitted in any form by any means, electronic, mechanical, photocopied, recorded, or otherwise, without prior written permission.

The information in this document is subject to change. Neither Carestream Health, Inc. nor any of its subsidiaries shall be liable for errors contained herein or for incidental damages in conjunction with the furnishing, performance, or use of this material.

Carestream is a trademark of Carestream Health, Inc.

The Kodak trademark and trade dress are used under license from Kodak.

All other trademarks and registered trademarks are the property of their respective holders.

US Federal law restricts this device to sale by or on the order of a dentist.

The Kodak 1500 intraoral camera is also marketed and sold as the STV Pro + intraoral camera.

Manual Name: KODAK 1500 Intraoral Camera User's Guide

Part Number: 8J2862

Revision Number: 02

Print Date: March 2010



Authorized Representative:



Carestream Health France
LES MERCURIALES
40. rue Jean Jaures
93176 BAGNOLET CEDEX
France

Handpiece:

FCC ID: U72KODAK1500H

IC: 7027A-KODAK1500

Docking Station:

FCC ID: U72KODAK1500

IC: 7027A-KODAK 1500

Contents

Chapter 1	Note to the User. v
About This Guide	Warning and Safety Instructions . . vi
	CAUTIONS: vi
	Marking and Labeling Symbols . . vii
Chapter 1	Camera Components 1
KODAK 1500	Wireless Camera 1
Intraoral Camera	Wired Camera 3
Overview	Camera Holder Components . . . 4
	Docking Station Components . . . 4
	Charge Station Components . . . 6
	System Components 8
Chapter 2	Computer System Requirements . .11
Acquisition Module	General Software Overview11
Overview	KODAK Dental Imaging
	Software12
	KODAK Acquisition Module. . .12
	Capture Window12
	Image Processing Toolbar . .16
Chapter 3	Setting Up the KODAK 1500 Intraoral
Getting Started	Camera17
	Inserting the Battery into a Wireless
	Camera.17
	Inserting the Cable into a Wired
	Camera.18
	Installing the Camera Holder. . . .18
	Setting up the Docking Station . .20
	Connecting the Docking Station
	to a Computer20
	Connecting the Docking Station
	to a Video Monitor.21
	Status Icons24
	Connecting the Antenna to the
	Docking Station26
	Pairing the Wireless Camera to the
	Docking Station.26
	Pairing One Camera to One
	Docking Station27

	Pairing One Camera to Several Docking Stations28
	Switching Computer29
	Setting up the Charge Station for a Wireless Camera31
	Connecting the Charge Station to the Docking Station.32
	Using the Charge Station as a Stand-Alone Device.33
	Using the Camera with a Protective Sheath34
Chapter 4	Acquiring Images Using a Video Monitor37
Acquiring, Reviewing, and Storing Images	Acquiring Images Using a Computer.38
Chapter 5	Hygiene and Disinfection.41
Maintenance	Maintenance.42
	Daily42
	Monthly.42
	Disposing of the Battery43
Chapter 6	Troubleshooting	
Chapter 7	Technical Features and Specifications	

1

About This Guide

This guide documents the KODAK 1500 intraoral camera and contains the following messages to emphasize information or indicate potential risk to personnel or equipment:



Warning: Failure to heed this warning could result in damage to property or in bodily injury.



Caution: Points out procedures that you must follow precisely to avoid damage to the system or any of its components, yourself, or others.



Note: Provides additional information, such as expanded explanations, hints, or reminders.



Tip: Provides extra information to improve workflow.

Note to the User

To use and operate your software, you must follow the instructions contained in this guide.

Warning and Safety Instructions

When operating the KODAK 1500 intraoral camera, observe the following warning and safety instructions:

DANGER OF ELECTRIC SHOCK



This is an electrical unit. **DO NOT** expose it to water spray. Such action may cause an electric shock or a malfunction of the unit.

CAUTIONS:



- You are responsible for the operation and maintenance of this camera. Only qualified persons can operate this camera. They **MUST** have training to use the camera. When necessary, have a trained authorized service technician carry out inspection and maintenance operations.
- **DO NOT** place the computer and the peripheral equipment connected to it in the immediate vicinity of the patient. Leave at least 1.83 m distance between the patient and the equipment.
- See your computer installation guide for details of the data processing system, computer and screen. Leave a sufficient amount of clear space around the computer to ensure that it is properly ventilated.
- To obtain maximum image quality and visual comfort, position the screen to avoid direct light reflections from internal or external lighting.

- **DO NOT** place objects within the field of operation of the equipment.
- Disinfect any parts of the camera that come into contact with the patient and the operator after each patient has been exposed to the camera.
- Always use a new protective sheath for each patient.
- Turn **OFF** the camera before charging. Failure to do so will shorten the life of the battery.
- The surface temperature of the LED window can rise up to 39°C. Do not allow the window to come in contact with the patient's mouth for more than 10 minutes.
- When the camera is not in use, ensure that the **ON/OFF** button is set to **OFF**.
- Ask the patient to refrain from moving during the entire period of exposure.
- The power adapter is certified by IEC 60601-1. You **MUST** use the provided AC Mains adapter only.

Marking and Labeling Symbols

	<p>Type BF device symbol complying with the IEC 60601-1 standard</p>
---	--

1

KODAK 1500 Intraoral Camera Overview

The KODAK 1500 intraoral camera is compliant with the requirements of the EEC and international medical standards.

The camera has been designed to carry out the following functions:

- Acquire still images and video
- Review images
- Store images

Camera Components

The camera is available in two models: wired and wireless. Although they look similar, the buttons and LEDs have different functions for different modes. The following illustrations describe the components and functions for wired and wireless models.

Wireless Camera

The wireless camera may be powered by a battery or a cable. If you use a cable, the functions of the LEDs and buttons are the same as those described for the wired camera.

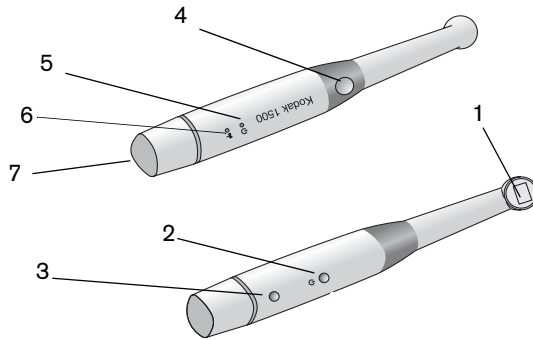

Figure 1 Camera Components—Wireless

1	LED and Lens window	View white LEDs that illuminate the oral cavity.
2	Power ON/OFF button	Press 3 seconds to power ON. Press 5 seconds to power OFF.
3	Battery Release button	Press button and pull battery out.
4	Shutter Release button	Press halfway down to perform auto focus. Press all the way down to capture an image. Press halfway down and release to return to video mode.
5	Battery indicator	Green indicates the battery is working properly; blinking orange indicates the battery is low.
6	WiFi indicator	Solid blue indicates the connection is working properly; blinking blue indicates a communications problem.
7	Battery	Insert rechargeable cylindrical Lithium-ion battery into bottom of camera until it fits tightly in place.

Wired Camera

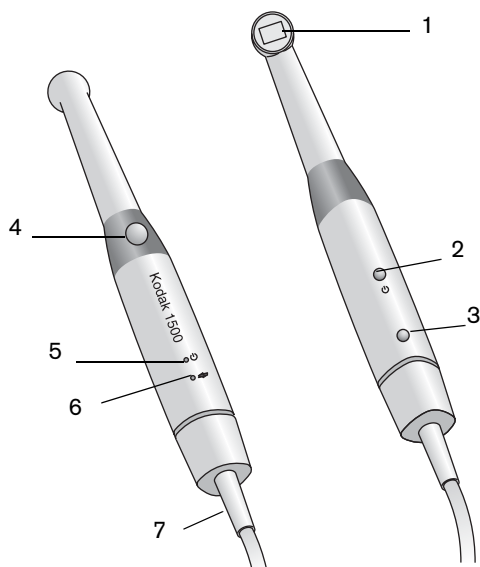

Figure 2 Camera Components—Wired

- | | | |
|---|--------------------------|--|
| 1 | LED and Lens window | View white LEDs that illuminate the oral cavity. |
| 2 | Power ON/OFF button | Press 3 seconds to power on. Press 5 seconds to power OFF. |
| 3 | Cable Release button | Press button and pull cable out. |
| 4 | Shutter Release button | Press halfway down to perform auto focus. Press all the way down to capture an image. Press halfway down and release it to return to video mode. |
| 5 | Power indicator | Green indicates the camera is powered on; no light indicates the camera is powered OFF. |
| 6 | USB Connection indicator | Solid blue indicates the connection is complete; blinking blue indicates the connection is in progress. |
| 7 | Cable | Insert cable into bottom of camera until it fits tightly in place. |

Camera Holder Components

Place the camera in the holder when you are not using the camera. See “Installing the Camera Holder” on page 18.

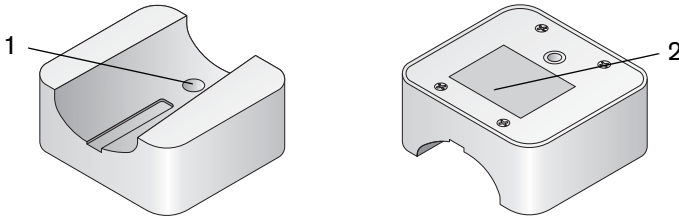

Figure 3 Camera Holder Components

- 1 Opening to fasten the holder securely to the surface
- 2 Adhesive tape



Note: After the camera is idle for 1.5 minutes, it switches to the idle mode. To use it again, pick it up or press the Shutter Release button. When the camera is idle for one hour, it shuts down.

Docking Station Components

The docking station provides connectivity and power for the camera. It lets you connect to a computer or a video monitor. The docking station contains the SD card slot and all the connections to use the camera.

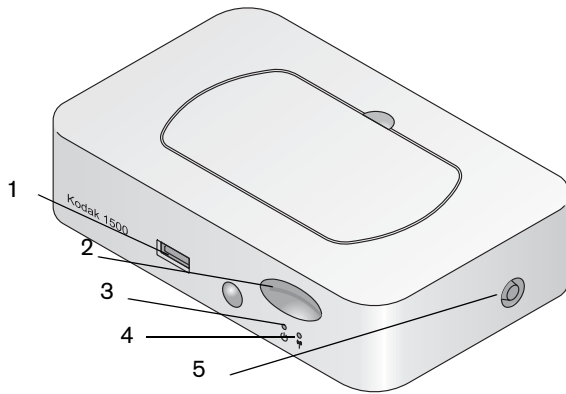

Front View

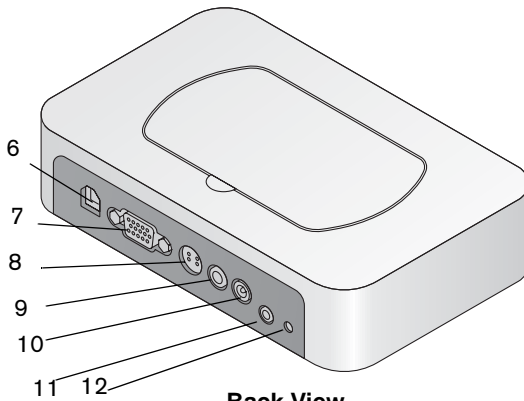

Back View

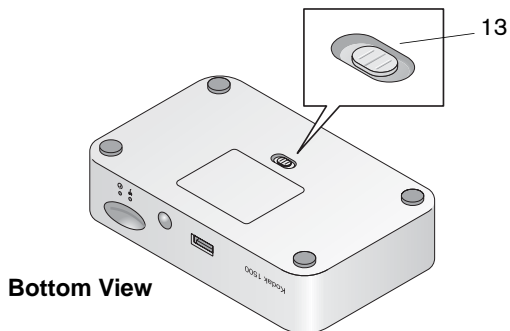

Bottom View

Figure 4 Docking Station Components

- 1 USB connector to camera
- 2 SD card socket
- 3 Power indicator: green = power normal; dark = no power
- 4 USB connection indicator (wired): blue = normal; blinking = not normal
WiFi indicator (wireless): blue = normal; blinking = not normal
- 5 Antenna connector (wireless)
- 6 USB connector to computer
- 7 VGA connector
- 8 S-video connector
- 9 AV-out connector
- 10 Power DC-in connector
- 11 Footpedal connector (optional accessory)
- 12 DC-out connector (wireless)
- 13 Output switch: NTSC, PAL, S-Video, VGA

Charge Station Components

The charge station is used to charge the wireless camera and the additional battery simultaneously or separately. You can use the charge station as a stand-alone unit or attach it to the docking station. The unit is used for wireless configuration only.

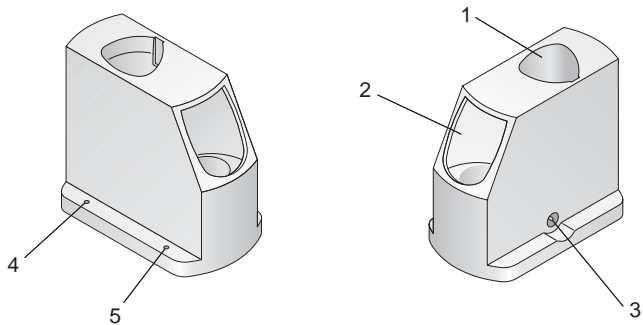

Figure 5 Charge Station Components

- 1 Camera port
- 2 Battery port
- 3 Power input
- 4 Camera indicator
- 5 Battery indicator

If the indicators are flashing, you must re-insert the battery to obtain good contact.



Note: If the camera is in the charge station for more than one hour, it shuts down.

System Components

The KODAK 1500 intraoral camera consists of a camera that captures video or still images when connected wirelessly or cabled to a computer or video monitor. If you use a computer, KODAK dental imaging software is required to view images. If you use a video monitor, additional software is not required.

Table 1 shows the system components for the KODAK 1500 intraoral camera.

Table 1 System Components





Item	Description
	1 camera
	1 camera cable
	2 rechargeable cylindrical Lithium-ion batteries (wireless)
	1 camera holder
	Protective sheaths

Table 1 System Components (Continued)



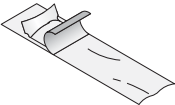

Item	Description
	1 docking station
	1 DC power cable and adapter
	1 AV cable
	1 S-video cable
	1 USB cable
	1 antenna (wireless)
	1 2G SD card

Table 1 System Components (Continued)

Item	Description
	1 charge station (wireless)
	Charge station power cord
Document and Software Package	CD containing: <ul style="list-style-type: none">• User's guide• Safety and Regulatory guide• Accessory Information Printed copies: <ul style="list-style-type: none">• Quick Start guide• Safety Information sheet• Warranty sheet

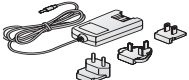
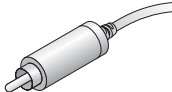
2 Acquisition Module Overview

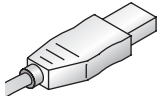
Computer System Requirements

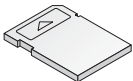
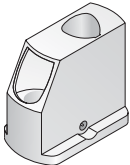
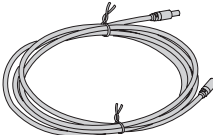
The computer must meet the following requirements:

- Intel Pentium IV, 1.8 GHZ or higher
- 512 MB RAM (1 G RAM for Windows Vista Ultimate, 32 bits)
- DVD drive
- Standard CRT/LCD monitor with a minimum of 1024 X 768 screen resolution
- Direct X 9.0c supporting video board
- USB 2.0 high-speed port

General Software Overview

The KODAK 1500 intraoral camera operates with the following software:

- KODAK dental imaging software, version 6.11.7 or higher
- Acquisition module

For more information, see the *KODAK dental imaging software Quick Start Guide*.

KODAK Dental Imaging Software

The KODAK dental imaging software is a user-friendly working interface, which is the common imaging platform for all of our digital systems for dentistry.

KODAK Acquisition Module

The following windows and settings are used in the KODAK Acquisition module.

Capture Window

The **Capture** window icon is located in the upper-left corner of the screen. Across the bottom of the window is a series of still thumbnail images of the entire exam.

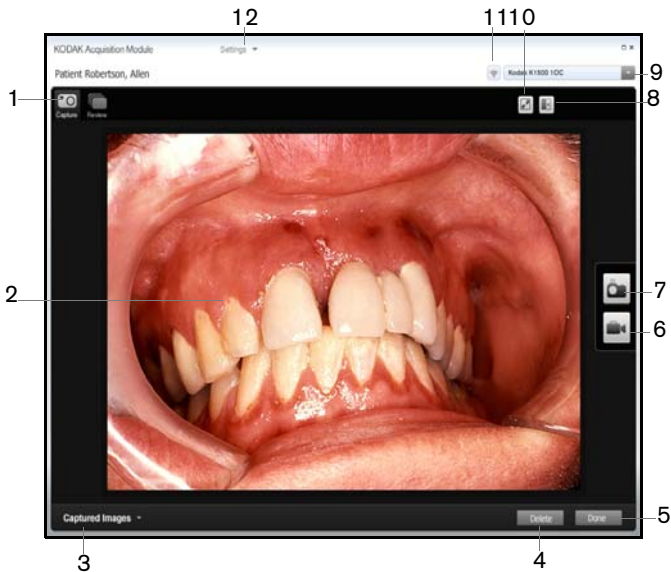

Figure 6 Capture Window

- 1 **Capture** button Displays the **Capture** window.
- 2 **Preview** screen Displays either live video or captured images.

- 3 **Captured Images** Displays or hides thumbnails of captured images and videos.
- 4 **Delete** button Deletes an image.
- 5 **Done** button Loads images into the KODAK dental imaging software and closes the acquisition module.
- 6 **Record Video** button Records video.
- 7 **Capture Still Image** button Captures still images.
- 8 **Mirror** button Displays live video in mirror mode.
- 9 Camera model Identifies the camera model.
- 10 **Full Screen** button Displays live video in full frame.
- 11 Connection status Identifies the strength of the connection.
- 12 **Settings** Displays user-adjustable settings for the acquisition module and camera.

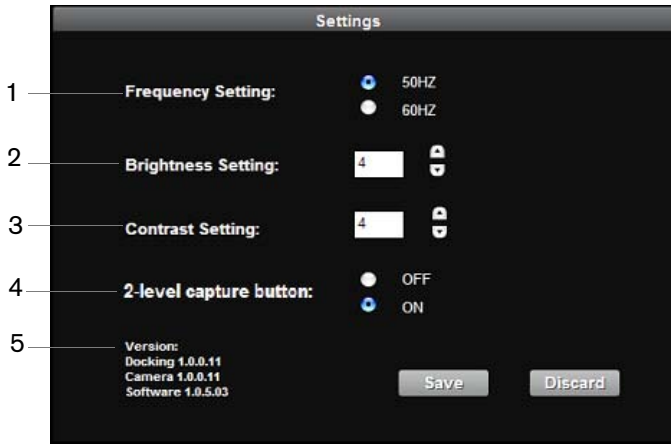

Figure 7 Settings Window

- | | | |
|---|-------------------------------|---|
| 1 | Frequency Setting | Selects the correct power frequency of your country. |
| 2 | Brightness Setting | Adjusts the brightness value from 1 to 7. |
| 3 | Contrast Setting | Adjusts the contrast value from 1 to 7. |
| 4 | 2-level capture button | Works as a 2-level button by default. You can change the Shutter Release button operation to work as a 1-level button by turning OFF this item. |
| 5 | Version | Displays the firmware versions of the docking station, camera, and acquisition software. |



Figure 8 Review Window

- | | | |
|---|----------------------------------|--|
| 1 | Review button | Displays the Review window. |
| 2 | Review screen | Displays a captured video or captured image. |
| 3 | Captured Images | Displays or hides thumbnails of captured images and videos. |
| 4 | Delete button | Deletes an image. |
| 5 | Done button | Loads images into the KODAK dental imaging software and closes the acquisition module. |
| 6 | Arrow buttons | Displays the next or previous images in the Review window. |
| 7 | Comment button | Displays the comment and tooth number functions. |
| 8 | Tooth Numbers input field | Input standard tooth numbers; use commas to separate the numbers. |

- | | | |
|----|---------------------------------|---|
| 9 | Image Processing toolbar | See "Image Processing Toolbar." |
| 10 | Comments input field | Displays the comment function. |

Image Processing Toolbar



Zoom In: Select to magnify the image or to switch viewing from 4-up to normal.



Zoom Out: Select to reduce the image or to switch viewing from normal to 4-up.



Mirror: Displays the image in Mirror mode.



Rotate: Rotates the image 90 degrees.



Brightness: Adjusts the brightness of the image.



Contrast: Adjusts the contrast of the image.



Reset: Adjusts all manual settings to the default settings.

3 Getting Started

Setting Up the KODAK 1500 Intraoral Camera

Refer to the System Component List and visually inspect the packages of the KODAK 1500 intraoral camera after the shipment is received. If there are any signs of damage or missing parts, contact the shipping company and Carestream Health, Inc. immediately.

Inserting the Battery into a Wireless Camera

To insert the battery into a wireless camera, hold the camera in one hand and push the battery into the bottom of the camera. Make sure the battery is locked into place.

To release the battery, press the Battery Release button and gently pull the battery out.

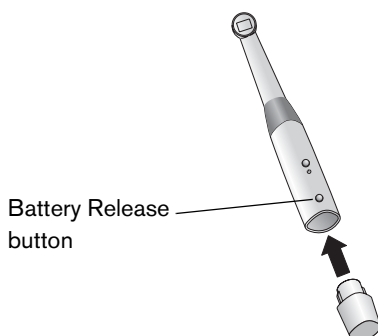

Figure 9 Inserting the Battery

Inserting the Cable into a Wired Camera

To insert the cable into a wired camera, hold the camera in one hand and insert the cable end into the bottom of the camera. Make sure the cable is locked into place.

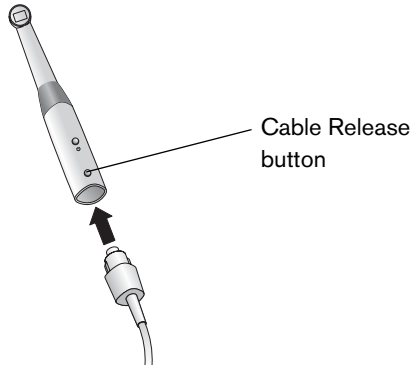

Figure 10 Inserting the Cable

To release the cable, press the Cable Release button and gently pull the cable out.

Installing the Camera Holder

To install the camera holder, follow these steps:

- 1 Choose a clean area on the wall that you can easily access.
- 2 Clean the surface on which you are going to fasten the camera holder.
- 3 Remove the adhesive tape protection from the support (2).
- 4 Place the taped side of the camera holder on the clean surface and press firmly several times for correct adherence. The maximum adherence is obtained after two hours. So, you must avoid all stress on the camera holder during the first two hours.

- 5 For places on which you cannot use the adhesive tape, insert a screw through the appropriate hole in the camera holder

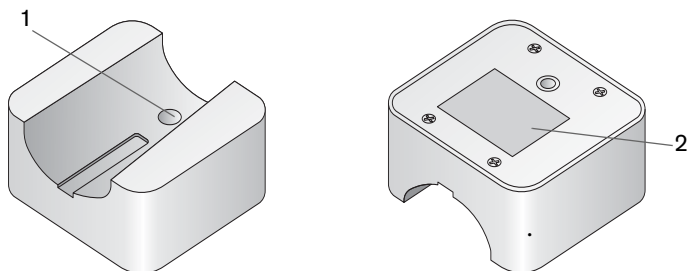

Figure 11 Top and Bottom Views of the Camera Holder



Note: If you use the adhesive tape to fix the camera holder, it may not be secure enough after a certain time period. Check the adherence regularly to ensure that it is secure.



Note: Carestream Health is not responsible for accidents involving the camera dropping due to loosening of the adhesive tape.



Note: The camera reverts to the idle mode when it is in the holder. If the camera is in the holder for more than one hour, it shuts down.

Setting up the Docking Station

Connecting the Docking Station to a Computer

To connect the docking station to a computer, follow these steps:

- 1 Connect the camera USB cable to the docking station (1).

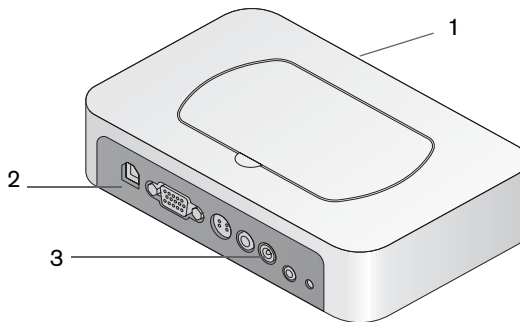

Figure 12 Connecting the Docking Station to a Computer

- 2 Connect the computer USB cable to the docking station (2).
- 3 Connect the other end of the USB cable to the computer USB port.
- 4 Connect the DC power supply into the docking station (3).

- 5 Insert the DC power cord into the power outlet. The power indicator on the front of the docking station turns green.

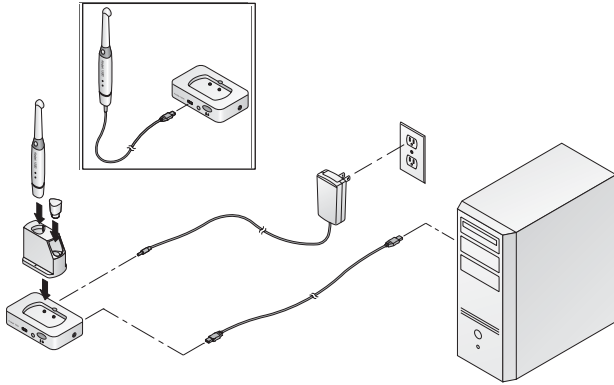

Figure 13 Set-up for a Camera and a Computer

Connecting the Docking Station to a Video Monitor

To connect the docking station to a video monitor, follow these steps:

- 1 Using the switch on the bottom of the docking station, switch the output to the correct video output: NTSC, PAL, VGA, or S-video (1).

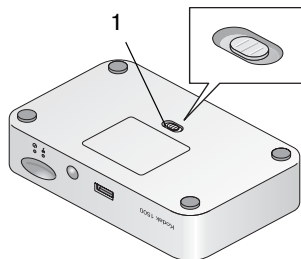



Figure 14 Bottom of Docking Station

- 2 Insert the SD card into the socket on the front of the docking station. Without the SD card, or if the card is full, the docking station can store the last 12 images. When the card is inserted, the images are transferred automatically to the card.

 **Caution: Do not remove the SD card while the docking station is powered ON until the SD card access icon at the lower-right of the monitor disappears.**

- 3 Select the correct video cable and connect to the docking station: VGA (2), S-video (3), AV-out (4).

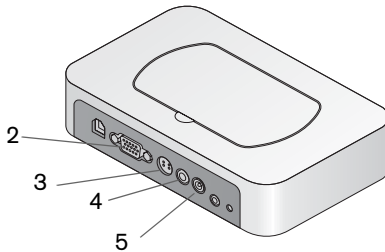

Figure 15 Docking Station Video Output

- 4 Connect the other end of the video cable to the monitor.

- 5 Connect the DC power supply to the docking station (5).
- 6 Connect the DC power cord to the power outlet. The power indicator on the front of the docking station turns green.

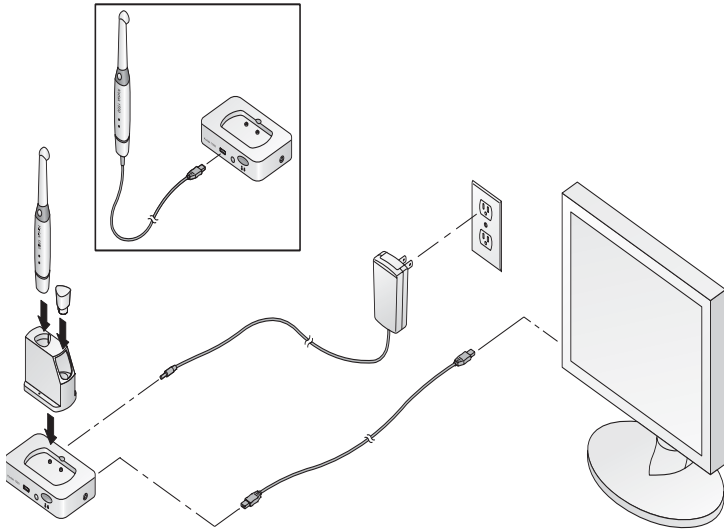

Figure 16 Set-up for a Camera and a Video Monitor

Status Icons



Low Battery



Sufficient Battery



Firmware Update Error



Firmware Update Successful



Firmware Update in Progress



No Connection between Docking Station and Camera



Connection between Docking Station and Camera via USB



Connection between Docking Station and Camera via WiFi



WiFi Code is Successful



WiFi Code Error



SD Card is Not Inserted



SD Card is Inserted



SD Card is Full



SD Card is Saving Files - Do Not Remove Card



Error Saving File to Internal Flash or SD Card



Saving to Internal Flash or SD Card Successful



Internal Cache is Full

Connecting the Antenna to the Docking Station

To connect the antenna to the docking station, screw the antenna into the connection on the right side of the docking station. Make sure the antenna is screwed tightly into the connection.



Figure 17 Docking Station with Antenna

Pairing the Wireless Camera to the Docking Station

Wireless cameras are paired at the factory to the docking station that is shipped with the camera.

The need to pair again a wireless camera to a docking station happens when:

- The original camera or docking station needs to be replaced.
- The user wishes to use one camera with two or more docking stations that are connected to computers in individual operatories. The pairing of one camera to two or more docking stations can only be used when

acquiring images using a computer, and not when acquiring images using a video monitor.

Pairing One Camera to One Docking Station

To pair one camera to one docking station, follow these steps:

- 1 Plug in the DC power cord and connect it to the docking station.
- 2 Connect the USB cable from the rear of the docking station to an open computer USB port.
- 3 Connect the camera USB cable from the front of the docking station to the camera.
- 4 Power ON the camera.
- 5 Open KODAK dental imaging software and the acquisition module in order to see live video on the computer.
- 6 Perform the pairing by continuously pressing down on both the camera Power On button and the Shutter Release button for at least five seconds until the following message appears on the computer monitor: "Docking station and Camera have paired successfully".
- 7 After pairing the docking station, replace the USB cable on the camera with a charged battery.
- 8 Restart the camera and operate it in wireless mode.

The camera can now be safely powered OFF. When you restart the camera, the blue WiFi indicators on the camera and the active docking station are ON.

Pairing One Camera to Several Docking Stations



Note: To pair one camera to several docking stations, you must connect each docking station to one specific computer.

To pair one camera to two or more docking stations, follow these steps:

- 1 Plug in the DC power cord and connect it to the docking station
- 2 Connect the USB cable from the rear of the docking station to an open computer USB port.
- 3 Connect the camera USB cable from the front of the docking station to the camera.
- 4 Power ON the camera.
- 5 Open KODAK dental imaging software and the acquisition module in order to see live video on the computer.
- 6 Perform the pairing by continuously pressing down on both the camera Power On button and the Shutter Release button for at least five seconds until the following message appears on the computer monitor: "Docking station and Camera have paired successfully".
- 7 To pair the camera to additional docking stations, repeat steps 1 to 6.
- 8 After pairing all docking stations, replace the USB cable on the camera with a charged battery.
- 9 Restart the camera and operate it in wireless mode.

The camera can now be safely powered OFF. When you restart the camera, it is automatically connected to the last active docking station. The blue WiFi indicators on the camera and the active docking station are ON.

Switching Computer



Note: Switching computer can only be performed if you have paired one camera to two or more docking stations..

To switch to another computer, follow these steps:

- 1 Go to the computer connected to the active docking station where work will be performed.
- 2 Select the "Activate Camera" button within the acquisition module.

The grey connection status icon appears next to the active camera button.

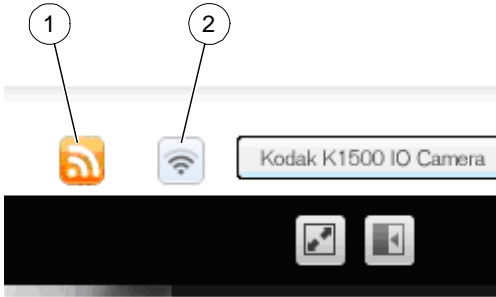

Figure 18 Connection Status

- 1 Activate Camera Button
- 2 Connection Status Icon
- 3 To acquire and save images on the current computer, proceed as when using a standard wireless camera.



Note: The computer used prior to switching reverts from active to idle.

Setting up the Charge Station for a Wireless Camera

You can attach the charge station to the docking station, or you can use it as a stand-alone device placed on a table. Make sure to place it in a safe and clean place, free from water, fire, and any magnetic field. Use the following guidelines for charging the camera:

- The camera port charges the camera with a single battery assembled.
- The charge station includes two indicators:
 - The left indicator displays the camera charging status.
 - The right indicator displays the battery charging status.

The indicator status is described in the following table:

Charging Status	Description
Solid Orange	Charging in progress
Solid Green	Charging completed
OFF	Absent battery or no power to charge station
Flashing	Poor contact

- The battery port charges an additional battery.
- The power comes from the docking station or from the power adapter.
- It takes two hours to charge the battery entirely.

- A fully charged battery lasts 45 minutes.



Note: If the indicators are flashing, you must re-insert the battery to obtain good contact.

Connecting the Charge Station to the Docking Station

To connect the charge station to the docking station, follow these steps:

- 1 Remove the top cover from the docking station.
- 2 Place the charge station on top of the docking station. Verify the connections and align the section correctly.
- 3 Press into place.

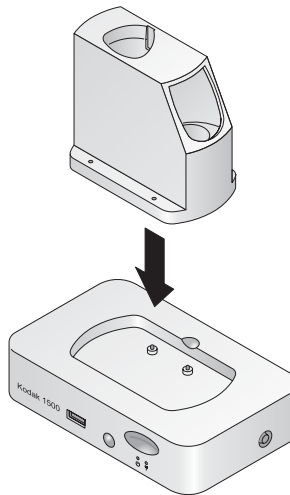

Figure 19 Charge Station with Docking Station

Using the Charge Station as a Stand-Alone Device

The charge station may be used as a stand-alone device that is powered by a wall outlet.

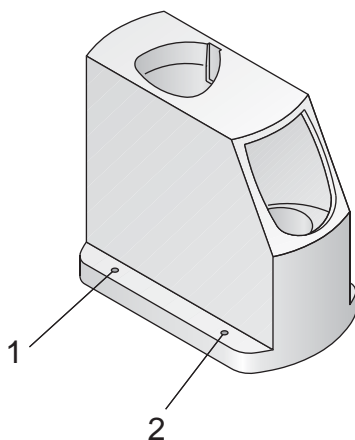

Figure 20 Charge Station Alone

- 1 Camera Indicator
- 2 Battery Indicator

To use the charge station as a stand-alone device, follow these steps:

- 1 Connect the charge station power cable to the power input (1).
- 2 Connect the power plug to a wall outlet.

- 3 Insert the camera or battery into the charge station.

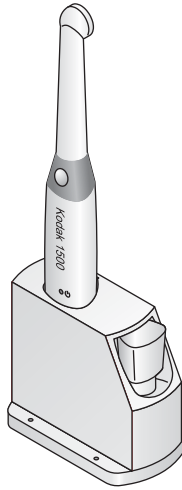

Figure 21 Camera in Charge Station

Using the Camera with a Protective Sheath

The protective sheath covers the camera and provides a sanitary shield for the patient. **Use a new sheath with each patient.** Always discard the sheath after each use. Extra protective sheaths are available from your dealer.

To use the protective sheath, follow these steps:

- 1 Make sure the window is clean by wiping it with a moist lint-free cloth or lens tissue.
- 2 Place the sheath, paper side down, on a flat surface.

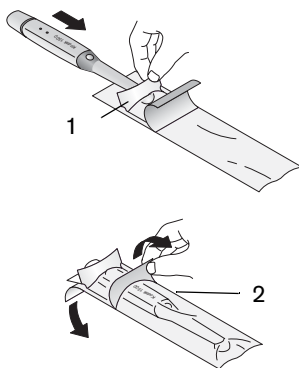

Figure 22 Camera Protective Sheaths

- 3 With the camera window facing down, insert the camera all the way into the sheath between the sheath's white tab and paper backing (1).
- 4 Hold the sheath in place on the camera by gently pressing the white tab against the camera with your thumb or finger.
- 5 Pull the blue tab on the front of the sheath straight down away from the camera (2) until the paper backing is pulled away. Discard, leaving the clear plastic sheath on the camera.
- 6 Adjust the sheath if necessary. The end should be tight to prevent fogging or blurring of the image.

4 Acquiring, Reviewing, and Storing Images

You can acquire images using the camera and a video monitor or computer. With the computer and the acquisition module, you can manipulate, label, and store images on your computer.

Acquiring Images Using a Video Monitor

When you acquire images using the camera with a video monitor, you can view live video and captured images. You can store up to 12 images in the docking station or an additional 10000 images on the SD card in the docking station.

If you want to manipulate, label, or store images, move the images from the camera and the SD card to your computer, and then view them using the KODAK dental imaging software with the acquisition module or any software capable of viewing **.jpg** images.

To acquire images using a video monitor, follow these steps:

- 1 Turn the video monitor ON.
- 2 Turn the camera ON by pressing and holding the Power ON button for at least 3 seconds until the green power indicator is illuminated.



Note: If you are using a wireless camera, verify the battery power level connection. See [“KODAK 1500 Intraoral Camera Overview”](#) on page 1.

- 3 Cover the end of the camera with a protective sheath. See [“Using the Camera with a Protective Sheath” on page 34.](#)
- 4 Hold the camera over the area you want to view. Live video appears on the video monitor.
- 5 To capture an image, press the Shutter Release button on the camera. The still image appears on the video monitor. See [“KODAK 1500 Intraoral Camera Overview” on page 1.](#)
- 6 Press the Shutter Release button on the camera half-way down and release it to view live video on the video monitor.
- 7 When the image capture is complete, remove and dispose of the protective sheath.

Acquiring Images Using a Computer



When you acquire images using the camera, a computer, the KODAK dental imaging software, and the acquisition module, you can view live video and captured images on your computer.

To acquire images using a computer, follow these steps:

- 1 Turn the computer ON.
- 2 Turn the camera on by pressing and holding the Power On button for at least 3 seconds until the green power indicator illuminates. See [“KODAK 1500 Intraoral Camera Overview” on page 1.](#)
- 3 Open KODAK dental imaging software on your computer.
- 4 Click the  button on the KODAK dental imaging software toolbar. The acquisition module opens, displaying the **Capture** window.

- 5 Click the  button in the acquisition module. The patient name displays in the upper-left of the window.



- 6 Cover the end of the camera with a protective sheath. See [“Using the Camera with a Protective Sheath”](#) on page 34.
- 7 Hold the camera over the area you want to view. Live video appears on the **Preview** screen in the **Capture** window.
- 8 To capture a still image, press the Shutter Release button. The **Acquisition** panel switches to the **Review** window, and the captured image is displayed in the **Preview** screen.
- 9 Press the Shutter Release button halfway down and release it to return to the **Capture** window and live video.
- 10 To record a video, click the  button in the **Capture** window. Click the red **Record** button  to stop video recording.
- 11 Remove and dispose of the protective sheath when the image capture is complete.



Note: If the camera is idle for 1.5 minutes, it switches to the idle mode.



Note: To use it again, pick it up or press the Shutter Release button.



Note: When the camera is idle for more than one hour, it shuts down.

5 Maintenance

Perform the following maintenance activities on your camera and accessories regularly.

Hygiene and Disinfection

The camera is delivered unsterilized. To ensure maximum hygienic safety for the patient, carefully follow the instructions in this user's guide to prepare the camera for use.

After each patient, the camera must be thoroughly disinfected.



Note: If the camera is visibly soiled, it must be thoroughly cleaned prior to disinfecting.



Note: The disinfectant should be approved by the applicable competent authority for use on a dental medical device.

To disinfect the camera, follow these steps:

- 1 Remove the protective sheath.
- 2 Use a clean, lint-free cloth to thoroughly wipe the camera with a disinfecting solution, being careful not to use too much liquid. Use an intermediate-level disinfectant with tuberculocidal activity, as recommended by the manufacturer of the disinfectant.

- 3 To adequately disinfect the camera, follow the disinfectant manufacturer's instructions for the appropriate contact time.



Caution: Do not use disinfectants containing phenolics or iodophors, which will damage the surface coating.



Caution: Never put the camera in a sterilizing device or immerse it completely.

Maintenance

Perform the following maintenance activities.

Daily

Perform these activities daily on the camera and docking station.

Table 2 Daily Maintenance

Description	User Instructions and Precautions	Cautions
Decontamination and Disinfecting	<ul style="list-style-type: none">• Prior to disinfectant remove all visible soil. Use a wipe to clean the camera.• Do not rinse.• Allow to dry in the open air.• Read the Disinfectant Material Safety Data Sheet (MSDS) prior to use.	Do not immerse the camera in a disinfecting liquid.

Monthly

Wipe the outer covers of the units with a soft, dry cloth.

Disposing of the Battery

The battery is a user-replaceable part ordered directly from the distributor or dealer. The battery comes inserted in a new camera bottom for easy installation into the camera. See “Inserting the Battery into a Wireless Camera” on page 17.



In the European Union, this symbol indicates that when a user discards this product, it must be sent to the appropriate facility for recovery and recycling.

Contact your local Carestream Health representative or access <http://recycle.carestreamhealth.com> for more information.

At the end of its useful life, properly dispose of the battery following all local regulations. Your community may offer a battery collection program. Check with program sponsors for participation details.

For information on disposal/recycling options in the European Union, see the European Portable Battery Association (EPBA) at <http://www.epbaeurope.net/>.

6 Troubleshooting

To troubleshoot a wired camera, see [Table 3](#).

Table 3 Troubleshooting a Wired Camera

Camera with Wired Configuration		
Video Monitor	Problems	Causes and Solutions
	No image is displayed on the screen.	<ul style="list-style-type: none"> • Make sure the power indicator LED on the docking station is green. • Make sure the power indicator LED on the camera is green. • Make sure the correct port is used to connect the docking station and the monitor.
	Image is blurred.	<ul style="list-style-type: none"> • Make sure the lens is not fogged. • Make sure the protective sheath is flattened against the lens and is placed properly (transparent side facing the lens).
	Colors are not true.	<ul style="list-style-type: none"> • Adjust the monitor contrast and brightness to change the colors.
Computer	Problems	Causes and Solutions
	No image is displayed on the screen.	<ul style="list-style-type: none"> • Make sure the power indicator LED on the docking station is green. • Make sure the power indicator LED on the camera is green. • Make sure the correct port is used to connect the docking station and the computer. • Make sure the camera drivers are installed correctly.

Table 3 Troubleshooting a Wired Camera (Continued)

Camera with Wired Configuration (Continued)	
Image is blurred.	<ul style="list-style-type: none">• Make sure the lens is not fogged.• Make sure the protective sheath is flattened against the lens and is placed properly (transparent side facing the lens).
Colors are not true.	<ul style="list-style-type: none">• Check the camera configuration in the KODAK dental imaging software manual.
Camera focuses on sheaths during auto focus process.	<ul style="list-style-type: none">• During the auto focusing process, the camera momentarily focuses on the sheath, before focusing on the correct item.
Cannot enter tooth number in Tooth number option.	<ul style="list-style-type: none">• Make sure the correct country/region for the tooth number standard is selected in the KODAK dental imaging software menu: Options > Preferences > Imaging > Tooth numbering system > European (Default)/American.



Note: The KODAK 1500 intraoral camera uses LED indicators to show the status of the camera. Be sure to note the color of the indicator if the camera is not functioning correctly.

To troubleshoot a wireless camera, see [Table 4 on page 47](#).

Table 4 Troubleshooting a Wireless Camera

Camera with Wireless Configuration		
Video Monitor	Problems	Causes and Solutions
	No image is displayed on the screen.	<ul style="list-style-type: none">• Make sure the power indicator LED on the docking station is green.• Make sure the status of the WiFi indicator in the camera and docking station are correct.• Make sure the correct port is used to connect the docking station and the monitor.
	Image is blurred.	<ul style="list-style-type: none">• Make sure the lens is not fogged.• Make sure the protective sheath is flattened against the lens and is placed properly (transparent side facing the lens).
	Colors are not true.	<ul style="list-style-type: none">• Adjust the monitor contrast and brightness to change the colors.

Table 4 Troubleshooting a Wireless Camera (Continued)

Camera with Wireless Configuration (Continued)	
Computer Problems	Causes and Solutions
No image is displayed on the screen.	<ul style="list-style-type: none">• Make sure the power indicator LED on the docking station is green.• Make sure the status of the WiFi indicator in the camera is correct.• Make sure the USB connection between the docking station and the computer is correct.• Make sure the camera drivers are installed correctly.
Image is blurred.	<ul style="list-style-type: none">• Make sure the lens is not fogged.• Make sure the protective sheath is flattened against the lens and is placed properly (transparent side facing the lens).
Colors are not true.	<ul style="list-style-type: none">• Check the camera configuration in the KODAK dental imaging software manual.
Camera focuses on sheaths during auto focus process.	<ul style="list-style-type: none">• During the auto focusing process, the camera momentarily focuses on the sheath, before focusing on the correct item.
Cannot enter tooth number in Tooth number option.	<ul style="list-style-type: none">• Make sure the correct country/region for the tooth number standard is chosen in the KODAK dental imaging software menu: Options > Preferences > Imaging > Tooth numbering system > European (Default)/American.

Table 5 Troubleshooting System Setup

Problem/Solution

Error message: ffdshow compatibility manager
TW.exe

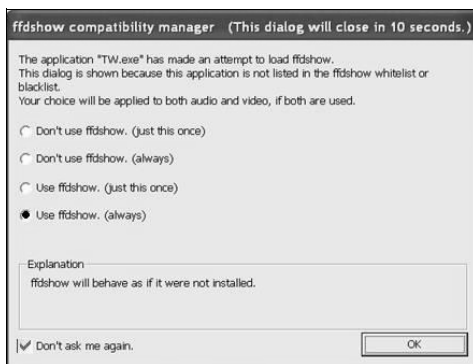

1. Select **Use ffdshow (always)** and **Don't show me again**.

2. Click **OK**.

Live video does not work.

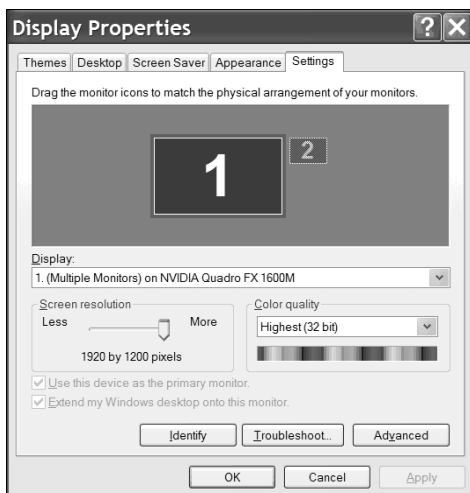

Make sure that the hardware acceleration of the computer graphics card is set up correctly .

To set the hardware acceleration of the computer graphics card, follow these steps:

1. Right-click the desktop window and select **Properties**.
2. Click the **Settings** tab.
3. Click **Advanced**.
4. Click the **Troubleshoot** tab.

Table 5 Troubleshooting System Setup (Continued)

Problem/Solution

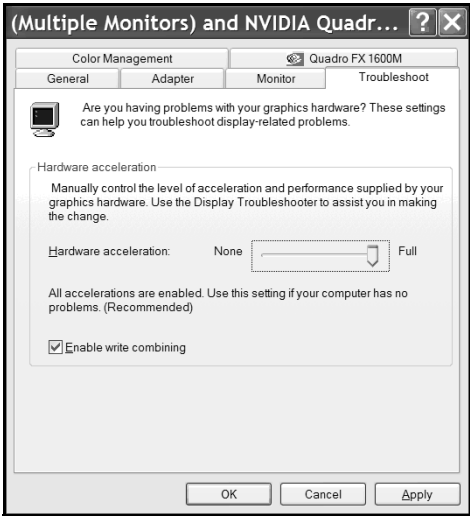

- 5. Set **Hardware acceleration to FULL.**
- 6. Select **Enable write combining.**
- 7. Click **Apply.**

7 Technical Features and Specifications

Table 6 provides the specifications for the KODAK 1500 intraoral camera.

Table 6 Technical Features and Specifications

Power supply	DC 6 V, 2.5 A
Video signal	S-Video; TV (PAL, NTSC); VGA
Digital connection	USB 2.0 high speed; WiFi 802.11 g
White balance	Automatic
Output impedance	75 ohm
Dimensions	Camera: 191 x 31 x 25 mm Docking station: 149 x 93 x 32 mm Charge station: 92 x 58 x 73 mm
Weight	Camera without cable/battery: 61 g Camera with battery: 91 g Docking station: 225 g (wireless), 215 g (wired) Charge station: 180 g
Environment	Operating temperature: +5 ~ +30°C Transit and storage temperature: -10–60°C Relative humidity: 10 ~ 85% RH Atmospheric pressure 700-1060 hPa Not protected against water spray

Table 6 Technical Features and Specifications

Output	<ul style="list-style-type: none"> 1 S-video output 1 PAL output 1 NTSC output 1 VGA video output 1 digital USB 2.0 output 1 SD card socket 1 DC power output
Camera	<ul style="list-style-type: none"> 1/2.5 inch CMOS with 1024 x 768 pixels Lighting: super white LEDs / Class 1 LED according to IEC 60825-1 Image capture: 1 Shutter Release button FOV: 80° View angle: 90° Connecting cable length: 2.5 m
Adapter	AC adapter complies with IEC 60601-1
Battery	750mAh; ICR17360 ISO75B37A1 manufactured by DLG Battery (Shanghai) CO., LTD



Caution: Not suitable for use in the presence of flammable anesthetics or a mixture of flammable anesthetics with air, oxygen, or nitrous oxide.

Carestream Health, Inc.
 150 Verona Street
 Rochester, NY 14608

© Carestream Health, Inc., 2010.

CARESTREAM is a trademark of Carestream Health, Inc.

The KODAK trademark and trade dress are used under license.